

REVISION HISTORY

Rev	DESCRIPTION	DATE	APPROVED

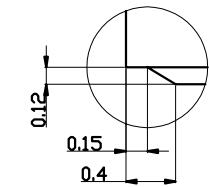
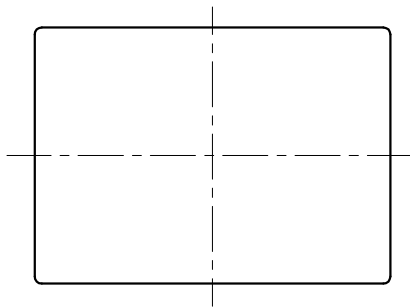
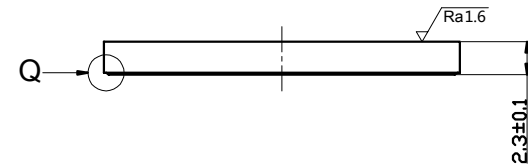
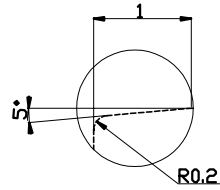
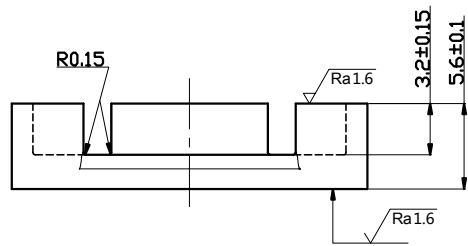
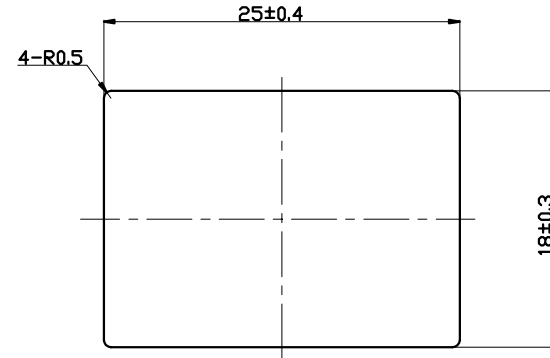
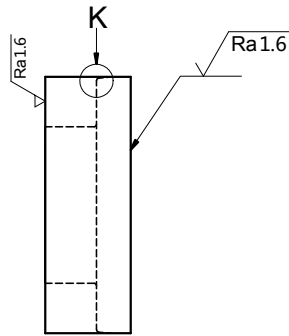
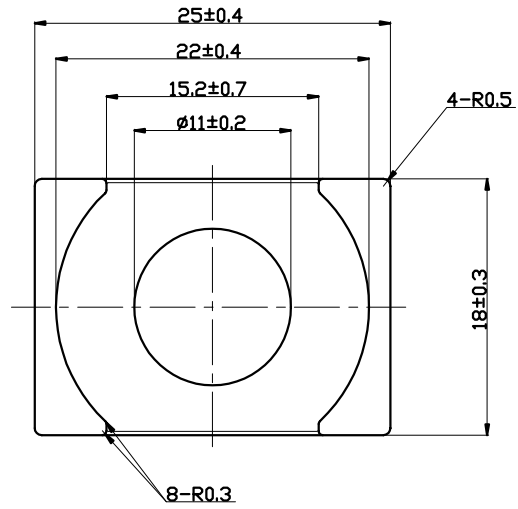

Detail K

Detail Q

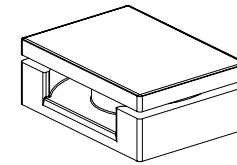

	Scale	Material	Customer Part number		
	2 : 1		EQ25/LP & PLT25/18/2		
	Unit:	Standard tolerances	Product Name		
	mm		±0.1	EIR-25-7.9-18	
Approved by	Created by	Document type	Rev	Drawing No.	
Y.Higuchi	Z.zhang	Production drawing	00	PY170707M05	
Hitachi Metals (Hong kong) ltd. Panyu Factory			Date of issue	Sheet	
			Jul 07 2017	1/1	